

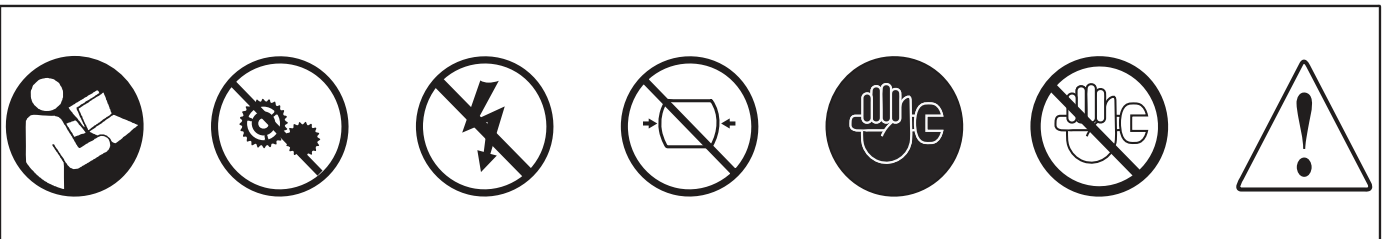

THERMO KING

Enregistreur TouchPrint Mode d'emploi

TouchPrint

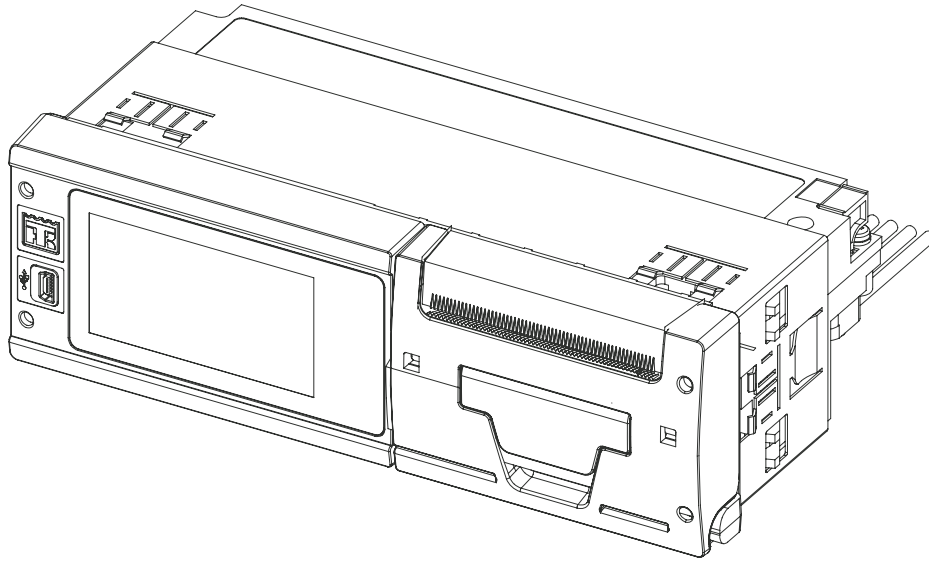

1. Changer le rouleau de papier

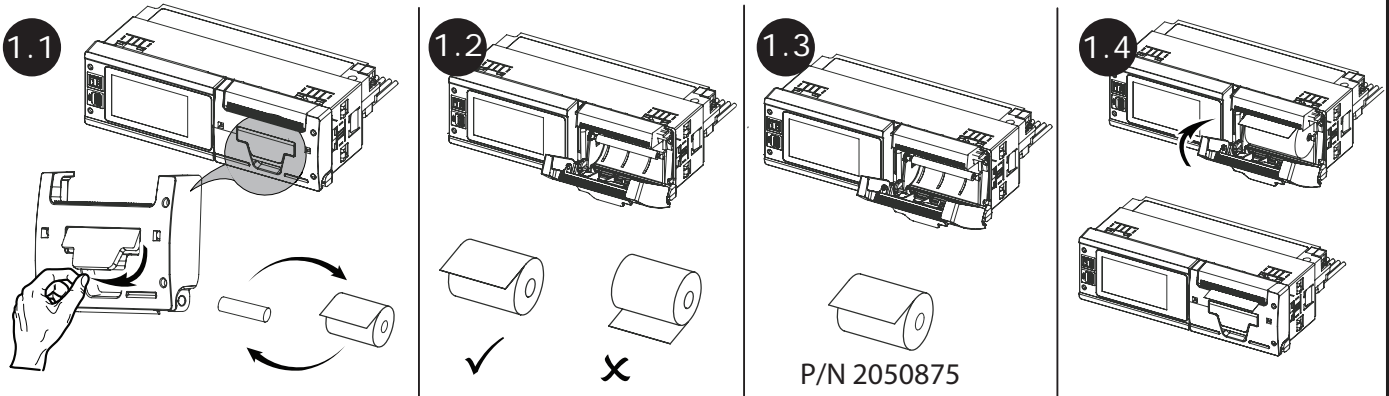

2. Opérations de base

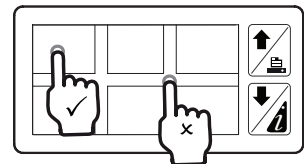
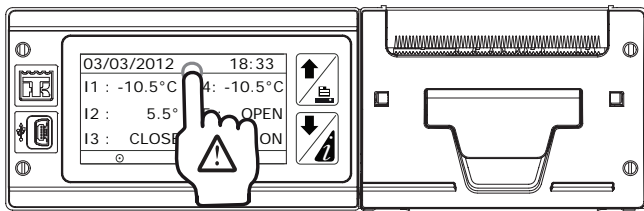

8 Bci hcbg



Quick Print



Quick Info

3. Menu principal

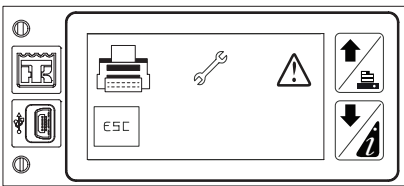

Print Menu



User Menu



Alarm Menu

4. Menu d'impression

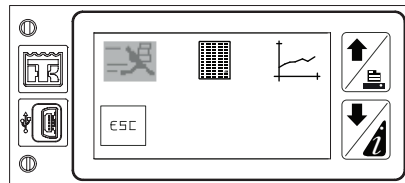
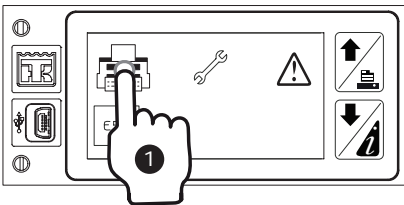

Delivery Ticket



Trip Ticket



Journey Ticket Graph

4.1 Imprimer un ticket de livraison

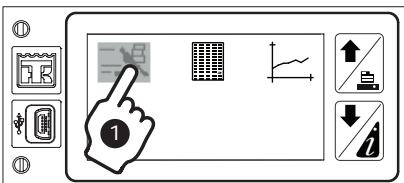

4.2 Imprimer un ticket de trajet

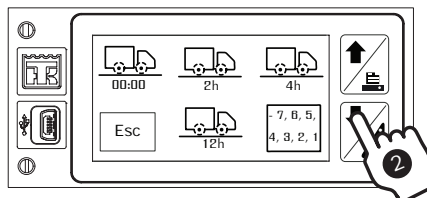
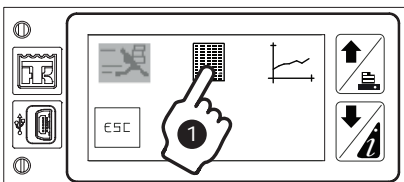

Midnight till now



Past 2 hours



Past 4 hours



Past 12 hours

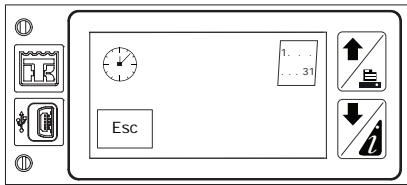

- 7, 0, 5,
4, 3, 2, 1

Specific day from the past 7 days



Specific start time to present time

1...
... 31

Specific start and end date

4.3 Annuler l'impression

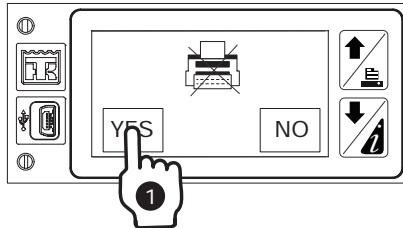
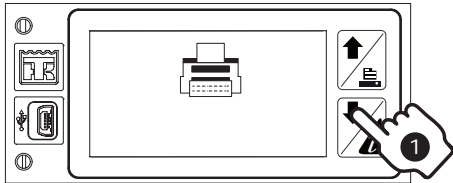

5. Menu de l'utilisateur

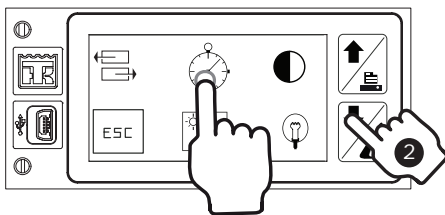
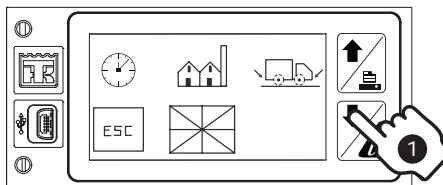
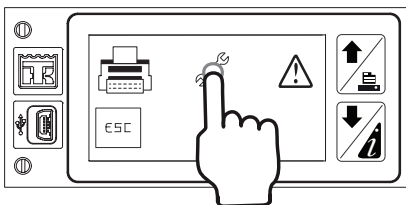

Adjusting the Time & the Date

Logging Interval

Company Reference

Contrast

Trailer ID

Daylight Saving Time Set

Language

Brightness

Input Setting

Touchprint Firmware

Temperature Unit

Media Selection For Printing

Export in Pdf/ txt

Labels

5.1 Changer la date et l'heure

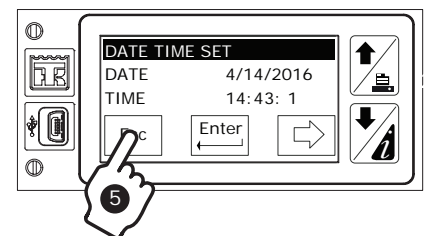
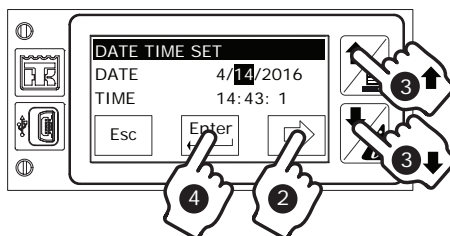
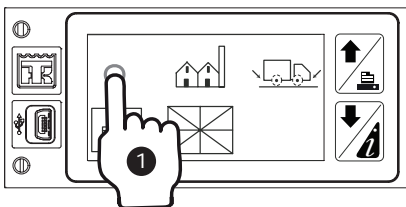

5.2 Changer les données de la société

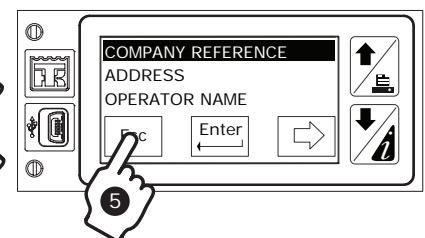
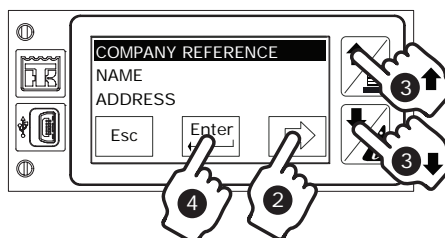
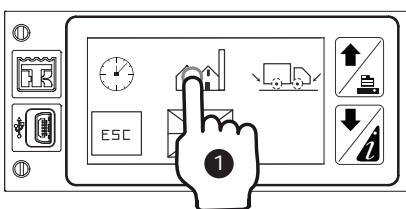

5.3 Changer les données du véhicule 

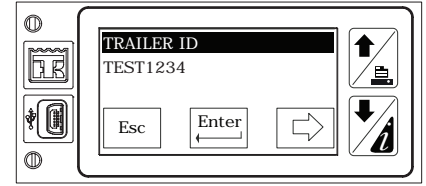
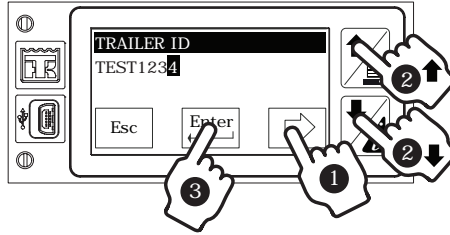
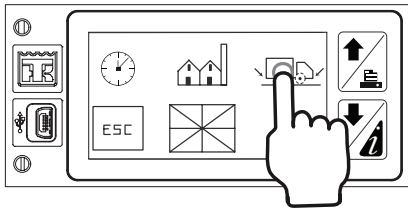

5.4 Changer la langue 

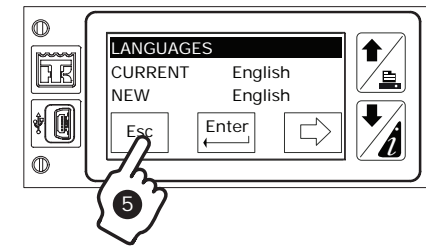
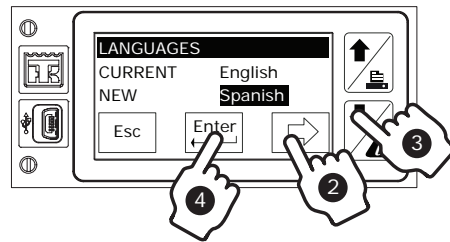
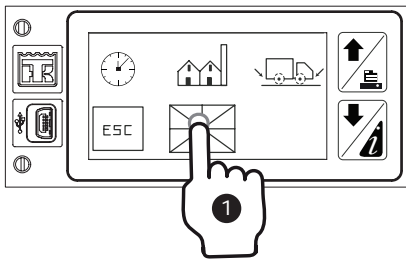

5.5 Changer l'intervalle d'enregistrement 

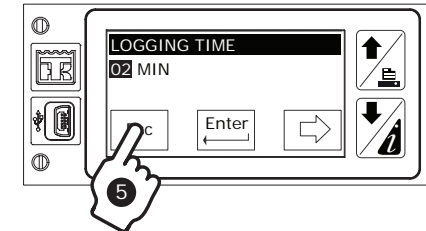
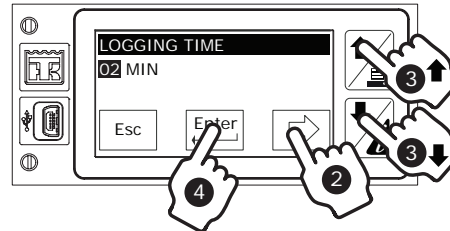
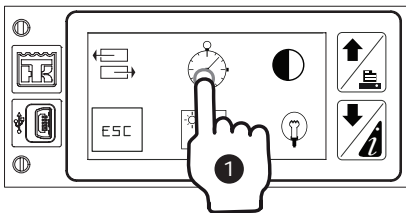

5.6 Changer le contraste 

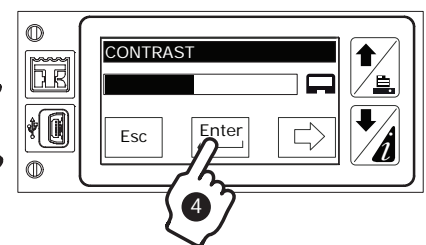
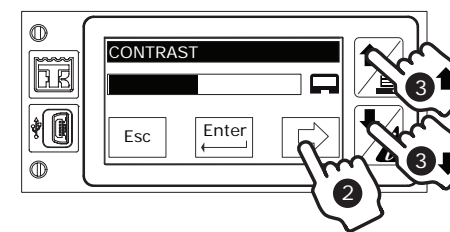
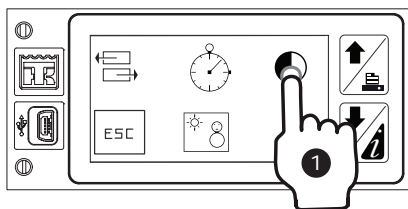

5.7 Réglage de l'heure d'été 

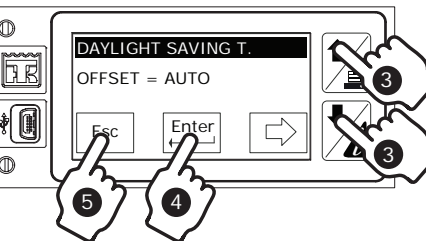
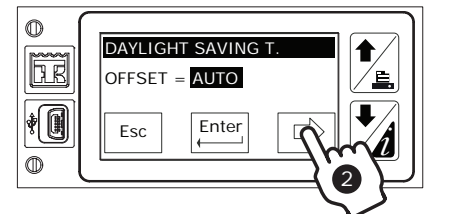
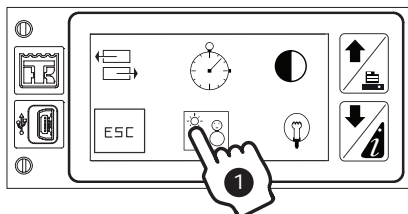

5.8 Changer le rétro-éclairage 

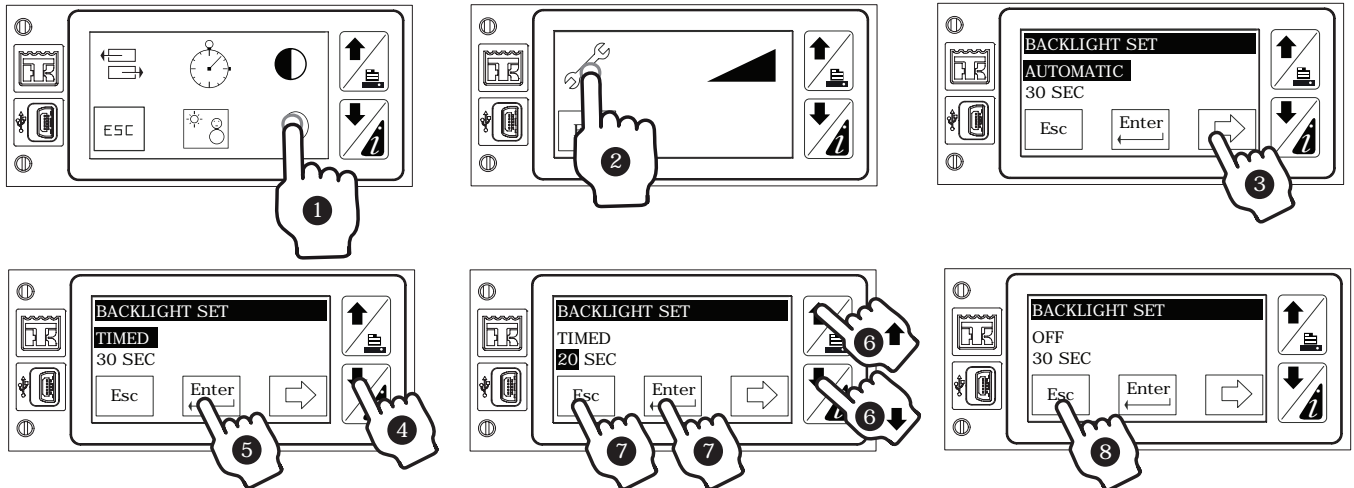

5.9 Changer la luminosité 

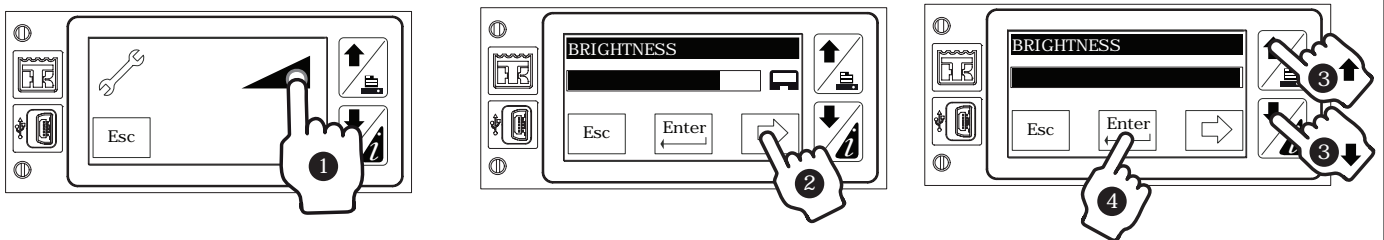

5.10 Sélection du type d'impression 

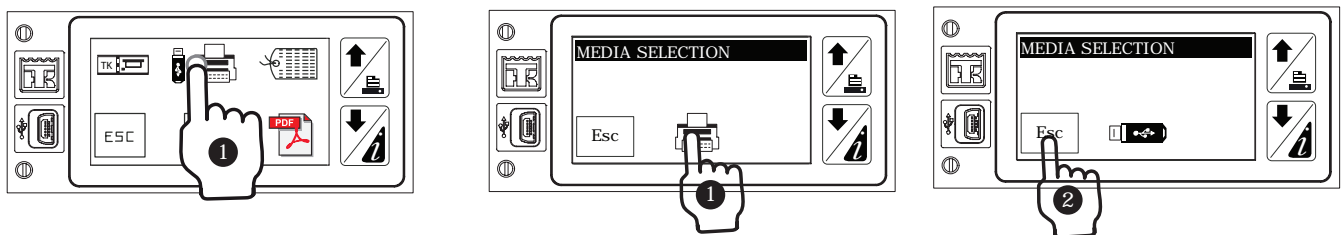

5.11 Changer l'unité de mesure de la température 

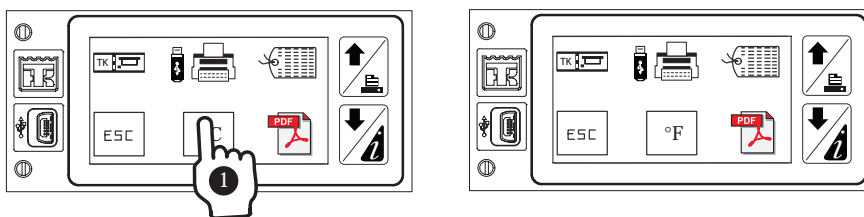

5.12 Exporter en format PDF ou TXT 

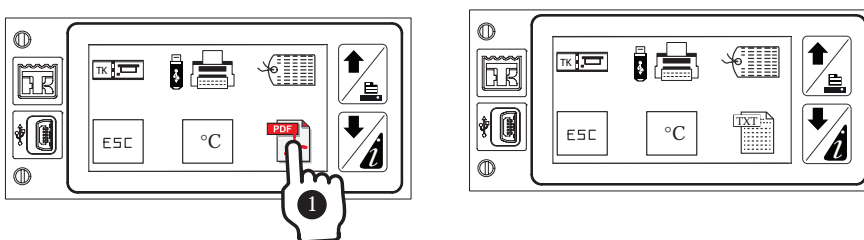

6. Menu des alarmes

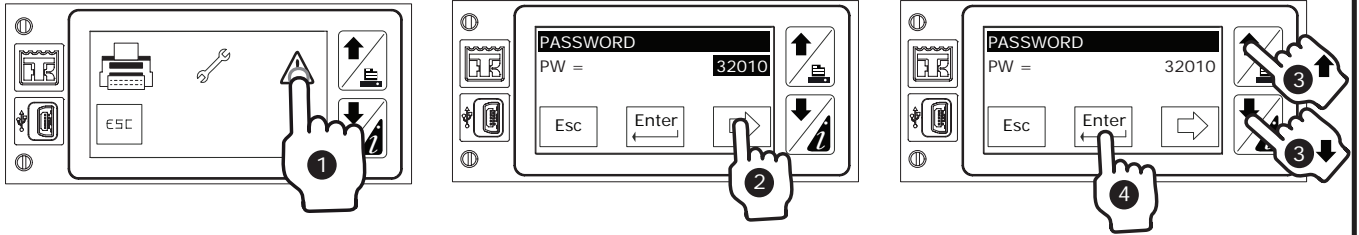

6.1 Sélectionner une plage de température

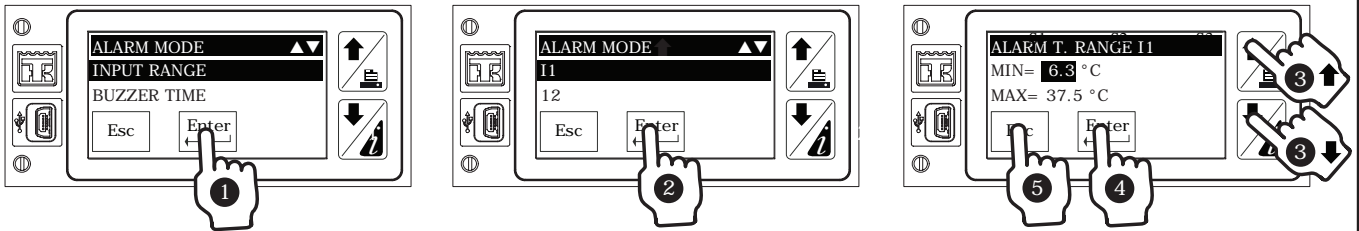

6.2 Sélectionner la durée de l'alarme

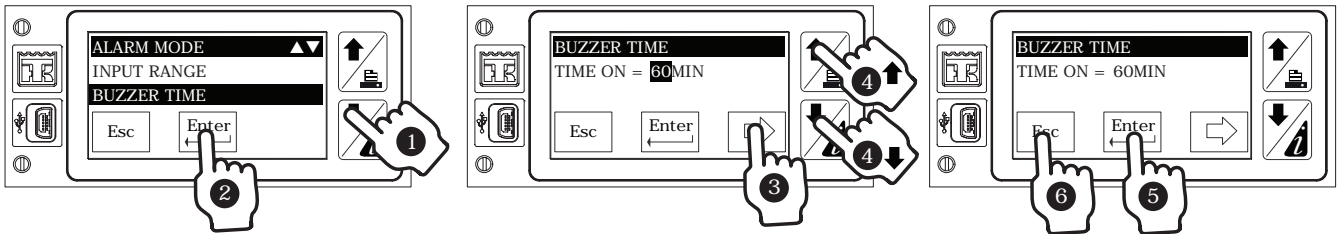

6.3 Sélectionner l'enregistrement de l'alarme

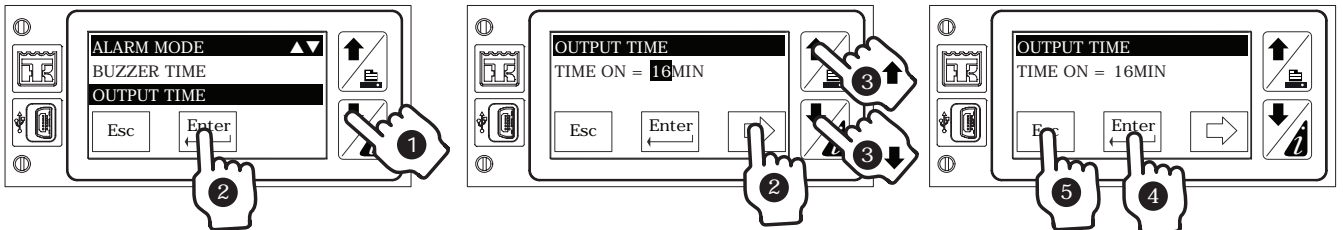

6.4 Effacer les alarmes

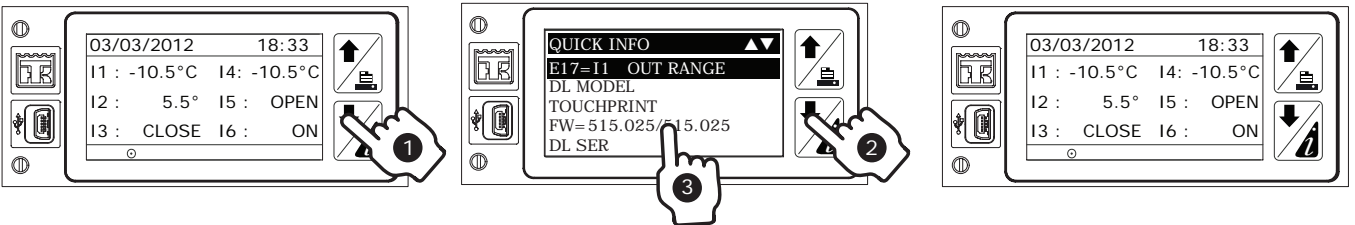

7. Opérations avancées

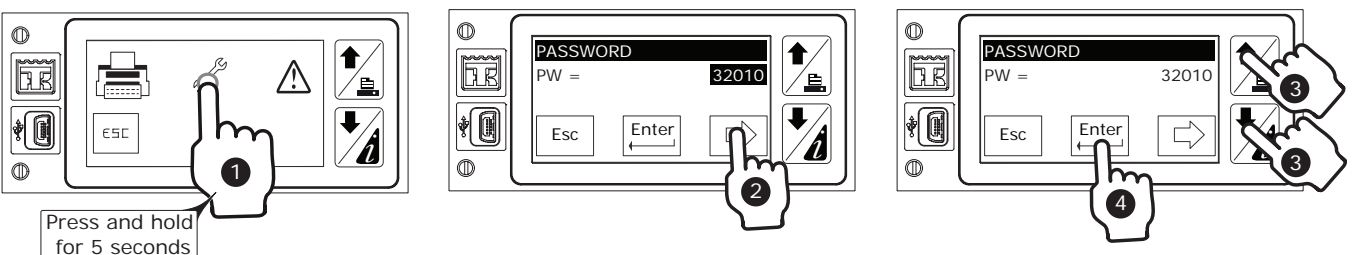

7.1 Menu d'entretien

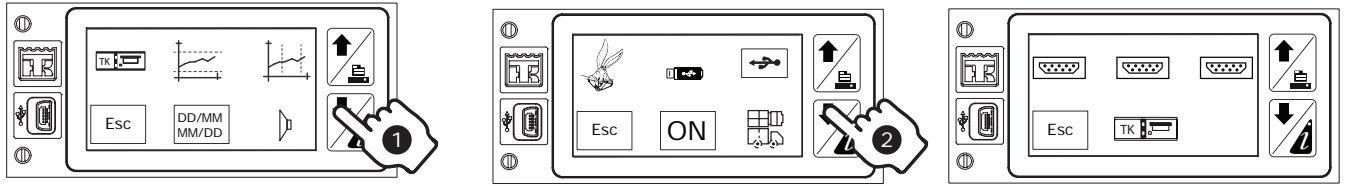

- Datalogger Model Name
- Temperature Range for Graph Printing
- Time Scale for Graph Printing
- Date Format
- Buzzer Sound
- Short Logging Interval
- Firmware Update
- Wintrac Interface Via USB
- ON/AUTO/OFF Data Logging
- Format Zone Selection
- UART Setting
- Trailer Vs Truck Installation

7.2 Données de l'enregistreur

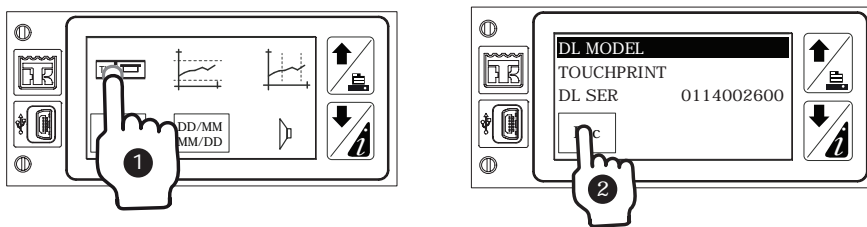

7.3 Plage de température pour les graphiques

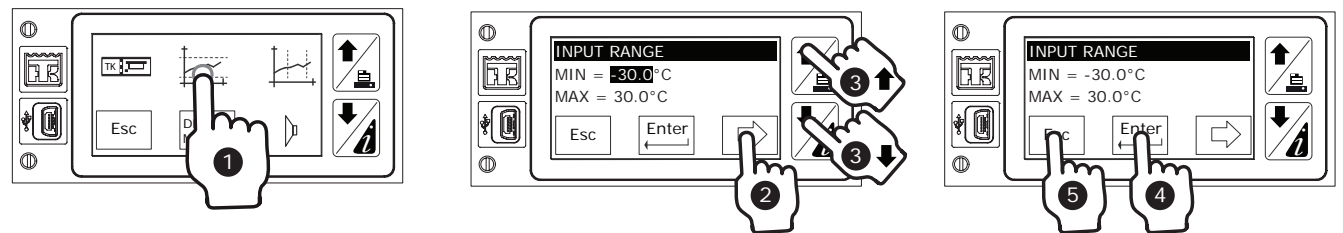

7.4 Echelle de temps pour les graphiques

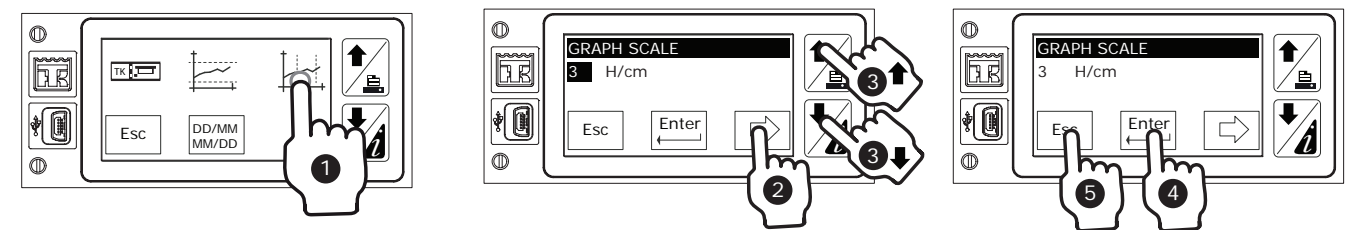

7.5 Format de la date

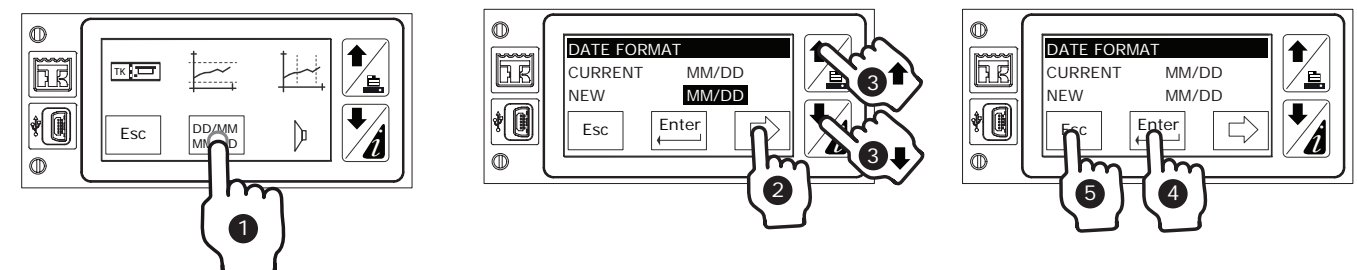

7.6 Activation de la sonnerie

7.7 Mise à jour du Firmware

7.8 Mode d'enregistrement des données

Note : Logging ONLY if pin 3 powered (reefer ignition connected).

7.9 Sélection de zone

7.10 Configuration Camion ou Remorque

TRAILER (12830,T,D,1,-30/30°C - ATP-MUC-1097 TS)

TRUCK (12830,T,B,1,-30/30°C - ATP-MUC-1096 TS)

S1 S2 S3